

# WindWise Education

*Transforming the Energy of Wind into Powerful Minds*

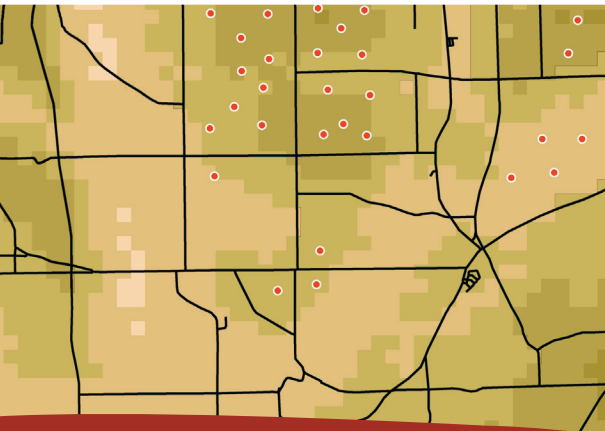
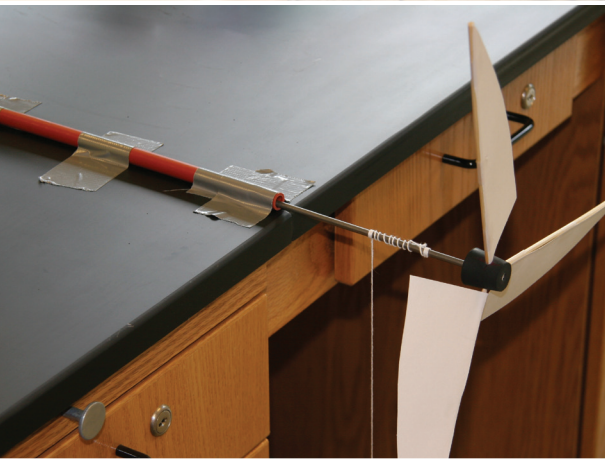

## A Curriculum for Grades 6–12

### Notice

Except for educational use by an individual teacher in a classroom setting this work may not be reproduced or distributed by mechanical or by electronic means without written permission from KidWind or Normandeau. For permission to copy portions or all of this material for other purposes, such as for inclusion in other documents, please contact Michael Arquin at the KidWind Project at [michael@kidwind.org](mailto:michael@kidwind.org)



2<sup>nd</sup>  
edition



[www.WindWiseEducation.org](http://www.WindWiseEducation.org)



WindWise Education was developed with funding from the New York State Energy Research & Development Authority



Updates to Lessons 3 & 5 and the addition of Lesson 16 were funded by the Department of Energy: subcontract No.AFT-I-40657-01

# WHICH BLADES ARE BEST?

## LESSON 10

### KEY CONCEPT

Students learn through experimentation how different blade designs are more efficient at harnessing the energy of the wind.

### TIME REQUIRED

1–2 class periods

### GRADES

6–8  
9–12

### SUBJECTS

Physics  
Technology/Engineering  
Mathematics

### BACKGROUND

The blades of a wind turbine have the most important job of any wind turbine component; they must capture the wind and convert it into usable mechanical energy. Over time, engineers have experimented with many different shapes, designs, materials, and numbers of blades to find which work best. This lesson explores how engineers determine the optimal blade design.

### OBJECTIVES

At the end of the lesson, students will:

- understand how wind energy is converted to electricity
- know the process of scientific inquiry to test blade design variables
- be able to collect, evaluate, and present data to determine which blade design is best
- understand the engineering design process

### METHOD

Students will use wind turbine kits to test different variables in blade design and measure the power output of each. Each group of students will isolate one variable of wind turbine blade design, then collect and present data for that variable. If time allows, students can use their collected data to design an optimal set of wind turbine blades using the next lesson, “How Can I Design a Better Blade?”

### MATERIALS

You will need one set of the following materials for each group:

- 1 model turbine on which blades can quickly be interchanged
- 1 multimeter or voltage/current data logger
- 1 box fan
- Milk cartons, PVC pipe, or paper towel rolls (optional)
- Ruler
- Pictures of wind turbine blades (see the Blade Design PowerPoint show in Additional Resources)
- Sample blades of varying sizes, shapes, and materials
- Balsa wood, corrugated plastic, cardstock, paper plates, etc.
- ¼" dowels
- Duct tape and/or hot glue
- Scissors
- Protractor for measuring blade pitch
- Safety glasses
- Poster-size graph paper (optional)
- Student Worksheets\*

\*included with this activity

## REDUCE DRAG

More Drag

Less Drag

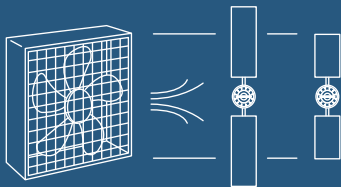
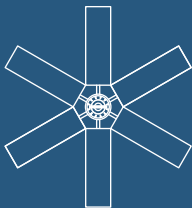

## GETTING READY

- Students should already have a basic understanding of wind energy, including the following:
  - what a wind turbine is
  - the fundamental parts of a wind turbine
  - how wind turbines transform energy from the wind
  - basic variables that impact turbine performance
- Most of this background was covered in the lesson “How Does a Windmill Work?” The additional resources listed at the end of this lesson also provide helpful information.
- The Blade Design PowerPoint found in the Additional Resources section will also be helpful for this lesson. This slideshow features descriptions of different blade designs and close-up pictures of wind turbine blades.
- Set up a safe testing area. Clear this area of debris and materials. Make sure the center of the fan is aligned with the center of the wind turbine. If you are working with multiple turbines, set them up so students will not be standing in the plane of rotation of a nearby turbine.
- Prepare three or four simple blade sets as samples for students to begin to see several variables and figure out how to build blades. Make sure the sample blade sets display different blade variables, such as length, material, and number of blades.
- Make copies of worksheets.

## ACTIVITY

### Step 1: Beginning questions for students

- What do you think makes one turbine work better than another?
- What variables affect the amount of **power** a turbine can generate?
- Do some variables matter more than others? (For example, is turbine height more important than the number of blades?)
- What do modern wind turbine blades look like? Is this similar to those on older windmills? Why?
- How many blades do most wind turbines have? What do you think would happen with more or fewer blades?

### Step 2: Brainstorm blade variables

Provide students with photos of different turbine designs, using the Blade Design PowerPoint or other photos found in the Additional Resources. Ask students to brainstorm some of the variables that affect how much energy the blades can capture while they are looking at the photos.

Variables may include:

- blade length
- number of blades
- weight/distribution of weight on blade
- blade pitch/angle
- blade shape
- blade material
- blade twist

**Step 3: Determining variables**

Organize students into small groups. Four students per group is optimal. Give each student a worksheet. Have each group select one variable to test. Length, number, pitch/angle, and shape are easy variables to test, but students can come up with additional variables as well. Before constructing blades, groups should determine what needs to be held constant in order to effectively test their variables.

If you are conducting this exercise as a demonstration, ask students which variable will perform better and why before testing it. Students will complete their worksheets while the teacher tests each variable. Students can take turns attaching blades or reading the [multimeter](#).

**Step 4: Building blades**

Depending on the variable being tested, some groups will have to build multiple sets of blades, while other groups will only build one set. For example, the group testing blade material will have to build one set of identical blades with each material being tested. The group testing pitch/angle, however, will only build one set of blades and then test the angle of these blades on the turbine. Groups should collect their blade materials, then work together to construct blades.

**Step 5: Testing blades**

The group will attach each set of blades to the turbine and test it at both high and low wind speeds. The group can change wind speed by moving the turbine away from the fan or turning the fan lower. Wind coming from a fan is very turbulent and does not accurately represent the wind a turbine would experience outside. To clean up this turbulent wind, students can make a wind tunnel by building a honeycomb in front of the fan using milk cartons, PVC pipe, or paper towel rolls. This will slow the wind coming off the fan, but it will also straighten it out.

Be sure students understand what [blade pitch](#) (angle) is and how they will measure it or keep it constant. This concept was introduced in “How Does a Windmill Work?”

Make sure that students keep pitch constant while testing other variables or the results can be problematic.

Students will measure the [voltage](#) with a multimeter and record their data on the worksheet. If time permits, ask students to do three replications of each variable and average their results.

**Step 6: Analysis**

Once students have collected their data, tell them to answer the questions on the worksheet and make a graph of their data to present to the class. If poster-size graph paper is available for students, ask them to replicate the graph on this paper for their presentations.

**BLADE PITCH**

Blade pitch is the angle of the blades with respect to the plane of rotation. The pitch of the blades dramatically affects the amount of drag experienced by the blades. Efficient blades will provide maximum torque with minimum drag. Measure pitch with a protractor.

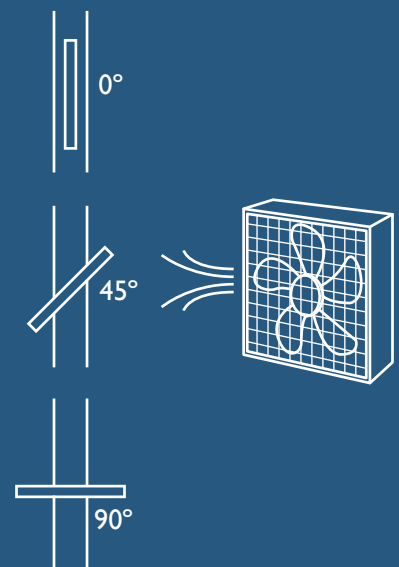

## WHICH BLADES ARE BEST?

### CAUTION!

- Do not stand in the plane of rotation of the rotor! You could be hit if your blade flies off during testing.
- The spinning rotor blades and metal rod can be dangerous. Make sure students work with caution.
- Be careful when working with the metal rod. Do not swing or play with the rod! The ends can be protected with tape, foam, cork, etc.
- Wear safety glasses when testing windmills. Safety glasses must be worn any time blades are spinning.

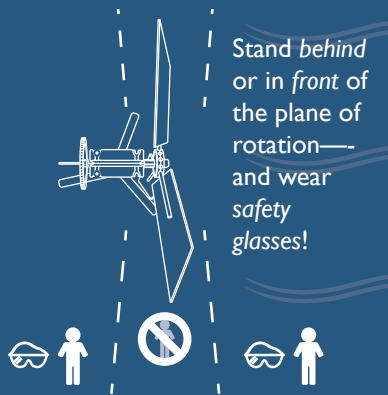

### Step 7: Presentation

Each group will have five minutes to present its data to the class. Students should discuss their variables, how they designed the blades, and the results. Ask all the students to record the results from each group on their worksheets so they have all of the class results.

### Step 8: Wrap up

Wrap up the lesson with some of the following questions:

- What variable has the greatest impact on power output?
- What type of blades worked best at low speeds? High speeds?
- What number of blades worked best?
- What shapes worked best?
- What length worked best?
- What problems did you encounter?
- Did longer blades bend backward in the wind? Was this a problem?
- What happened when the diameter of the turbine rotor was bigger than the diameter of the fan?

Ask students to analyze the class data and describe an optimal blade design. If time permits, this can be used as a starting point for the extension lesson: “How Can I Design a Better Blade?”

## EXTENSION

The following extension may be made for grades 9–12:

- Ask students to also collect **amperage** data and calculate power. Discuss voltage, amperage, and power and how they relate to one another.
- Ask students to determine the efficiency of their turbines. The efficiency of a turbine is a comparison between the theoretical power available in the wind and the actual power output of the turbine. To calculate the theoretical power in the wind, students can use this equation:

$$P = \frac{1}{2} \rho (\pi r^2) V^3$$

$P$  = total power available in the wind

$\rho$  = air density (1.23 kg/m<sup>3</sup> at sea level)

$\pi$  = pi (3.14)

$r$  = rotor radius (length of one blade)

$V$  = velocity of the wind

Turbine efficiency is equal to the total power output of the turbine divided by the theoretical power available. Do not be surprised if your efficiency is under 5 percent. The maximum theoretical efficiency of a wind generator is 59 percent. Research Betz Limit to learn more about this.

## VOCABULARY

amperage – A measure of the rate of flow of electrical charges.

$$1 \text{ ampere} = \frac{1 \text{ volt}}{1 \text{ ohm}} = \frac{1 \text{ watt}}{1 \text{ volt}} \text{ or } 1 \text{ amp} = \frac{V}{R} = \frac{P}{V}$$

blade pitch – Angle of the blades with respect to the plane of rotation. (Blades perpendicular to the oncoming wind would be 0 degrees. Blades parallel to the wind would be 90 degrees).

drag – In a wind turbine, also called wind resistance. The friction of the blades against air molecules as they rotate. Drag works against the rotation of the blades, causing them to slow down.

lift – A force encountered by the blades that is perpendicular to the oncoming flow of air. Lift is a force working to speed up the rotation of the blades.

multimeter – An electronic instrument that can measure voltage, current, and resistance.

power – The rate at which energy changes form from one form to another, or the rate at which work is done

voltage – The electrical pressure or potential difference that drives the electric current.  $1 \text{ volt} = 1 \text{ amps} \times 1 \text{ ohm} = 1 \text{ watts} / 1 \text{ amps}$

wattage – the metric unit of power. In electricity, one watt of power is equal to one ampere of electric current being forced to move by one volt of potential difference. One watt is also equivalent to one joule of energy per second.  $1 \text{ watt} = 1 \text{ volt} \times 1 \text{ amp}$ .

## USE A MULTIMETER WITH YOUR WIND TURBINE

Students need to know how to record voltage and amperage with a simple multimeter.

Make sure you have done this yourself and can explain it to the students. It is important to ensure that the units are correct. If you multiply volts by milliamps, you will get a confusingly large and incorrect number for power. It is okay to just record voltage, which can make things easier.

Small DC motors do not produce much power when spun slowly. A wind turbine without gears will not get more than 2 volts. On a wind turbine with gears, power output can be increased (2–8 volts) using gears to spin the shaft of the generator faster than the hub.

Go to <http://kwind.me/r2b> for a video on using a multimeter.



### RELATED ACTIVITIES

- Lesson 8: How Does a Windmill Work?
- Lesson 11: How Can I Design Better Blades?
- Advanced Blades Appendix

### ADDITIONAL RESOURCES

DANISH WIND ENERGY ASSOCIATION—<http://kwind.me/u9p>—Guided Tour: How Does It Work?

KIDWIND, CLASSROOM WIND TURBINES—<http://kwind.me/h9c>—KidWind has compiled a list of ideas for building your own wind turbine. This site also includes complete kits, instructions on how to build model turbines, and more ideas for classroom activities.

KIDWIND, WIND TURBINE VARIABLES—<http://kwind.me/g7c>—This site explains the different wind turbine variables.

KIDWIND WEB COMPETITION—<http://kwind.me/x8h>— Show-off your small wind turbine building skills.

WIND TURBINE BLADE DESIGN—<http://kwind.me/h0f>—PowerPoint slide show

WIND WITH MILLER—<http://kwind.me/f9j>—This is a good introduction to wind energy and wind turbines. Great for grades 6–8.

**More advanced explanations of wind turbine science, better for grades 9–12.**

NATIONAL RENEWABLE ENERGY LABORATORY—<http://kwind.me/e4c>—Search for wind turbines and blades; you will also find a wide range of wind energy images.





# ENERGY TRANSFERS AND CONVERSIONS IN A TURBINE

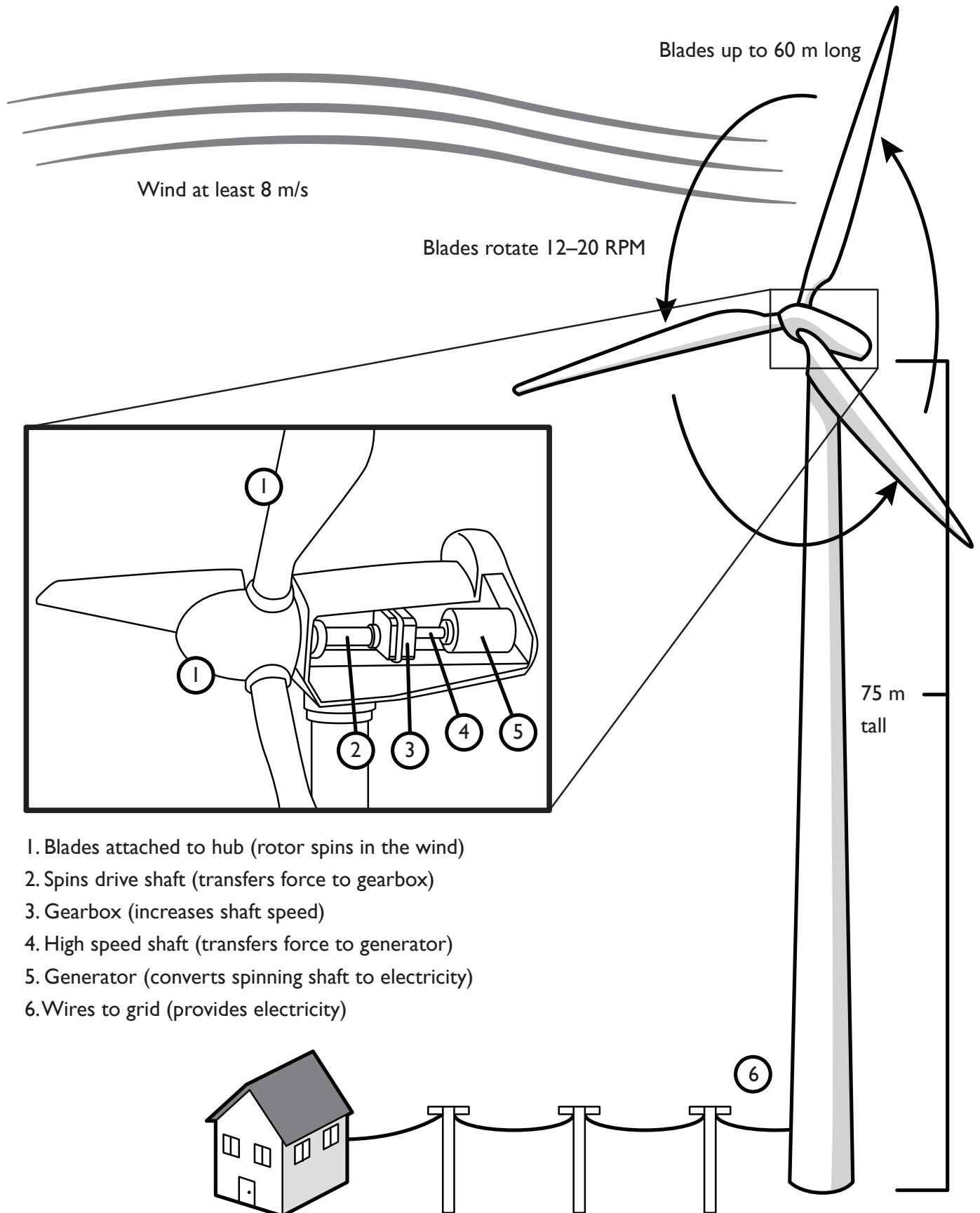

## Which Blades Are Best?



## Student sheets

Name \_\_\_\_\_

Date \_\_\_\_\_

Class \_\_\_\_\_

### Variable

What variable will you test for your experiment? \_\_\_\_\_

### Constants

What variables do you have to keep the same (constant) as you perform this experiment?

### Experimental design

Describe how you will perform this experiment.

1. What materials will you use?
2. How many times will you test your variable?
3. How long will you run the test?
4. How will you change your variable?
5. What will you use to measure your output?

### Hypothesis

1. What do you think will happen?
2. Why do you think this will happen?



**Data tally sheet: grades 6–8**

	<b>LOW SPEED</b>	<b>HIGH SPEED</b>
<b>VARIABLE</b> (e.g., length, in cm)	<b>VOLTAGE</b> (mV or V)	<b>VOLTAGE</b> (mV or V)

**Graph your data**

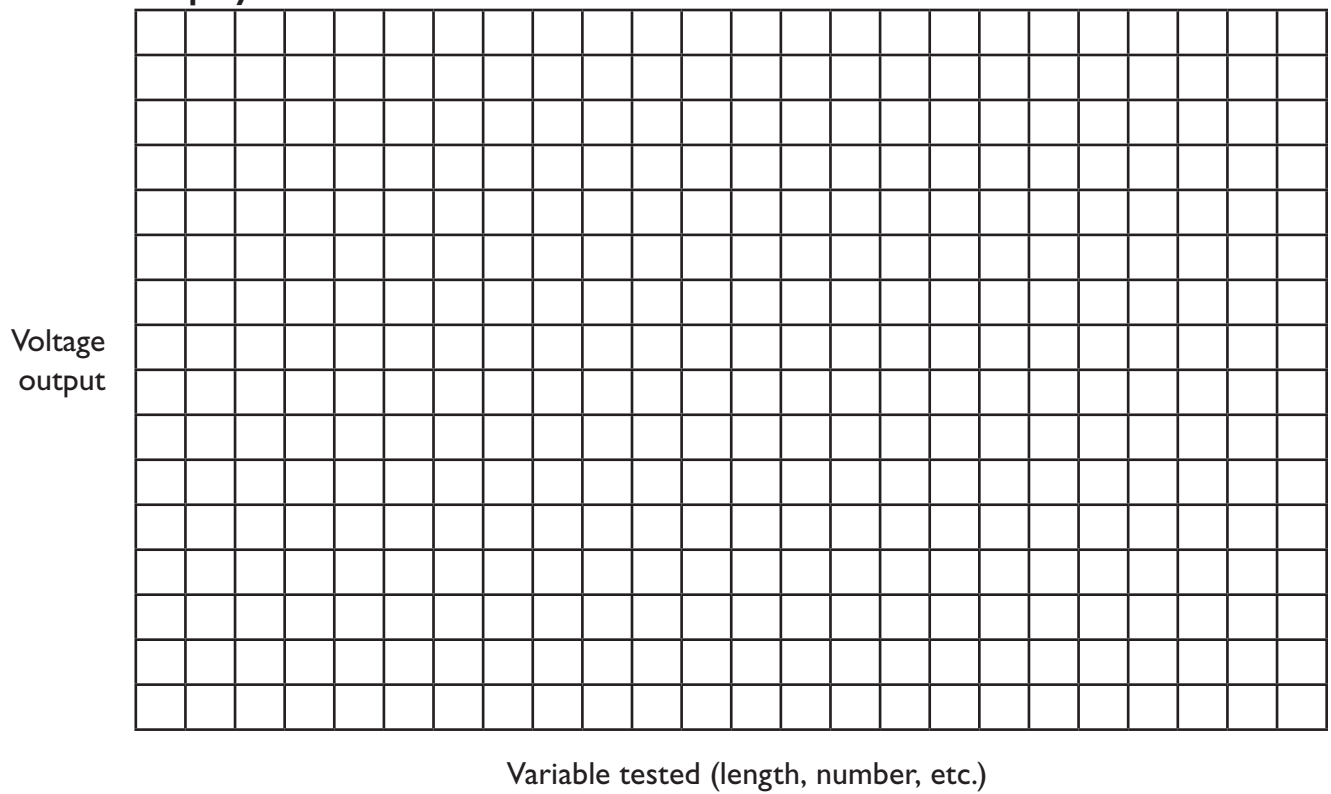

Data tally sheet: grades 9–12

<b>LOW SPEED</b>			
<b>VARIABLE</b> (e.g., length, in cm)	<b>VOLTAGE</b> (mV or V)	<b>AMPERAGE</b> (mA or A)	<b>(V × A) = POWER</b> (mW or W)

<b>HIGH SPEED</b>			
<b>VARIABLE</b> (e.g., length, in cm)	<b>VOLTAGE</b> (mV or V)	<b>AMPERAGE</b> (mA or A)	<b>(V × A) = POWER</b> (mW or W)

Graph your data

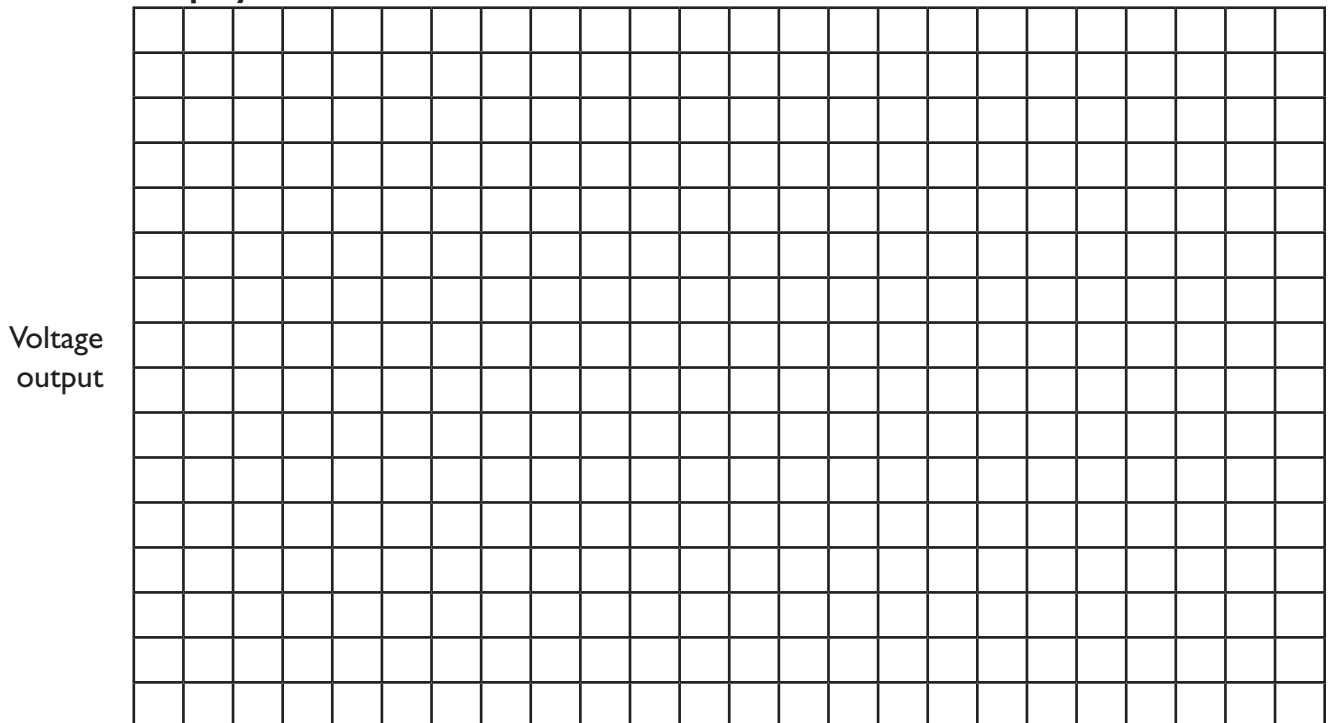



Name\_\_\_\_\_

Date\_\_\_\_\_

Class\_\_\_\_\_

**What happened?**

1. How did the voltage change as a result of manipulating the variable?
  
  
  
  
  
  
  
  
  
  
2. What was the optimal setting for the variable that you tested?
  
  
  
  
  
  
  
  
  
  
3. Do you think that the variable that you tested has a large or small effect on how much power the turbine can make?
  
  
  
  
  
  
  
  
  
  
4. What problems did you encounter as you performed your experiments? How could you fix these problems?

**Class results**

Record the results from the class experiments in the table below.

**Power = Voltage (V) × Current (A)**

Make sure you are recording volts and amps (not milliamps). 1 A=1,000 mA

VARIABLE (e.g. length cm)	VOLTAGE (V)	AMPERAGE (extension) (mA or A)	POWER OUTPUT (optional) (mW or W)
15 cm	1.7	<b>100 mA</b>	<b>0.17 W</b>

- If you were a lead design engineer, what would you recommend your company do to their turbine blades based on the class results? Why?

**Variable**

What variable will you test for your experiment?

*Answers will vary. Example variables: Blade pitch, blade shape/size, material of blades, number of blades, etc.*

**Constants**

What variables do you have to keep the same (constant) as you perform this experiment?

*Answers will vary. Example variables: Blade pitch, blade shape/size, material of blades, number of blades, etc.*

**Experimental design**

Describe how you will perform this experiment.

1. What materials will you use?

*Answers will vary. Balsa, corrugated plastic, paper plates, cardboard, etc.*

2. How many times will you test your variable?

*Variables should be tested at least twice.*

3. How long will you run the test?

*Answers will vary. Trials should last at least 20 seconds.*

4. How will you change your variable?

*Answers will vary.*

5. What will you use to measure your output?

*Output should be recorded using a multimeter or other quantitative measurement.*

**Hypothesis**

1. What do you think will happen?

*Students should hypothesize about how changing their chosen variable will affect the power output of the wind turbine.*

2. Why do you think this will happen?

*Students should explain why they think changing the variable will affect power in this way.*

**What happened?**

1. How did the voltage change as a result of manipulating your variable?

*Changing the variable should cause the voltage to increase or decrease.*

2. What was the optimal setting for the variable that you tested?

*Which trial yielded the most voltage? For example, if the test variable is “blade pitch,” students may answer “Blades pitched at 20 degrees produced the most voltage.”*

3. Do you think that your variable has a large or small effect on how much power the turbine can make?

*Answers will vary.*

4. What problems did you encounter as you performed your experiments? How could you fix these problems?

*Answers will vary. One common problem is that it is hard to keep all other variables constant while testing one specific variable.*

**Class results**

Record the results from the class experiments in the table below.

**Power = Voltage (V) × Current (A)**

1. If you were a lead design engineer, what would you recommend your company do to their turbine blades based on the class results? Why?

*Students should describe the optimal blade design based on class results. This answer should discuss at least three variables—e.g., length of blades, number of blades, blade pitch, blade material, etc.*